

Figure 6.1 Tile Dimensions

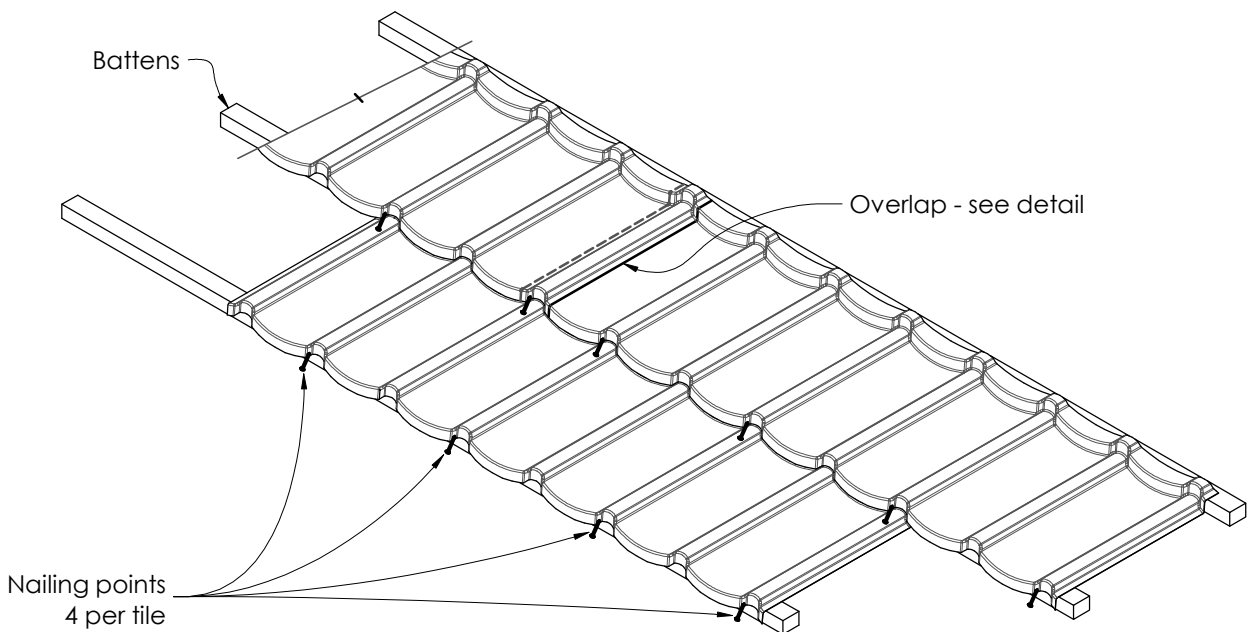

Figure 6.2 Nailing Detail

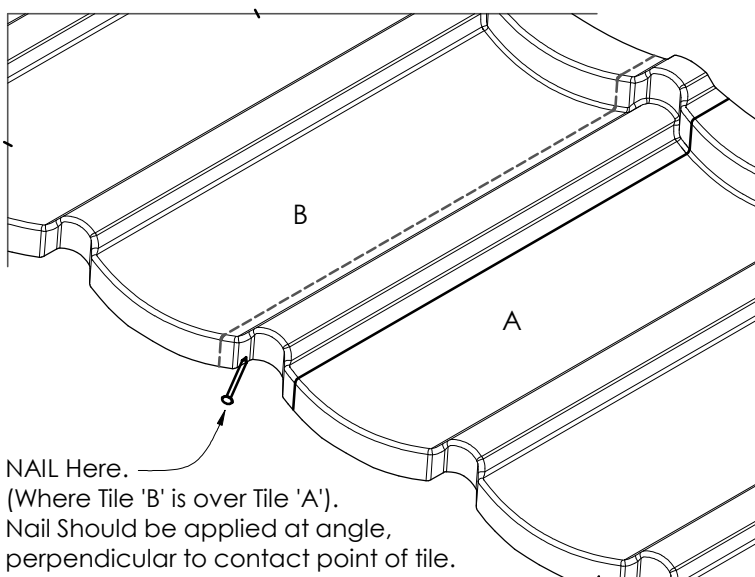

Figure 6.3 Overlap Detail

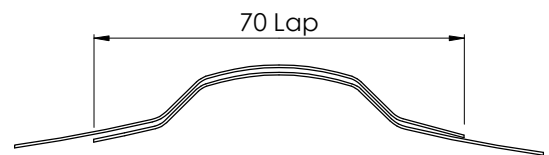

Figure 6.4 Lap Section

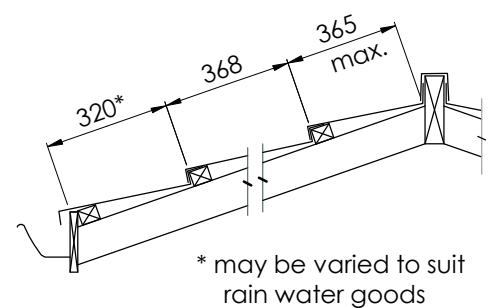

Figure 6.5 Batten Layout